

FEATURES

Single Turn/ Cermet/ Industrial/ Sealed.
9 Terminal Styles.

DRAWING (mm)

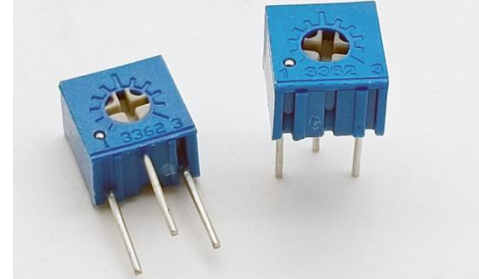

WTP-3362

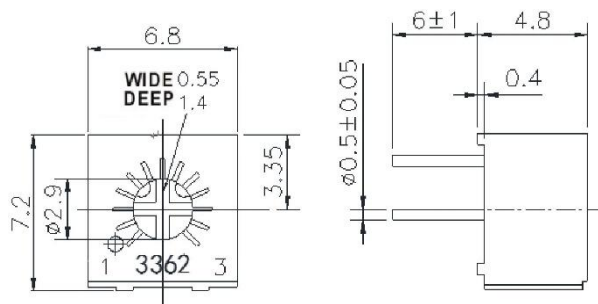

WTP-3362H

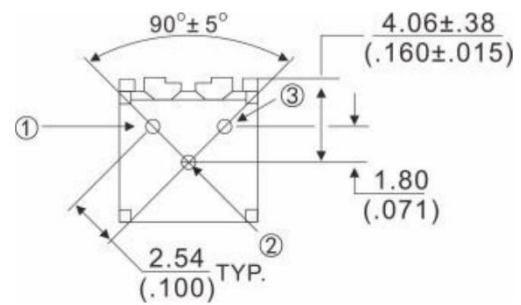

WTP-3362R

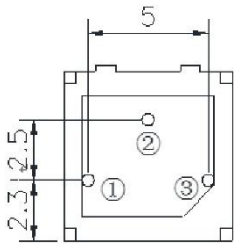

WTP-3362P

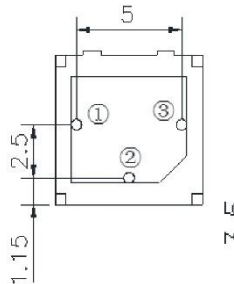

WTP-3362U

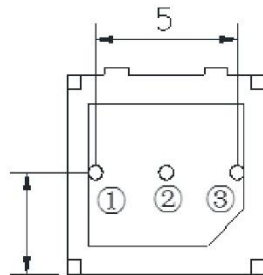

WTP-3362S

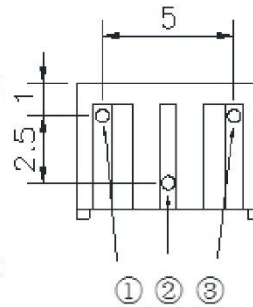

WTP-3362X

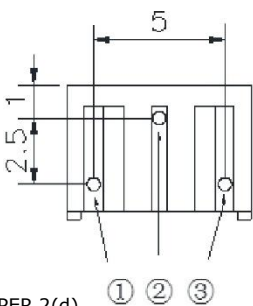

WTP-3362W

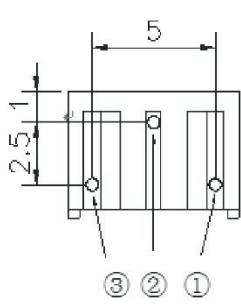

WTP-3362Z

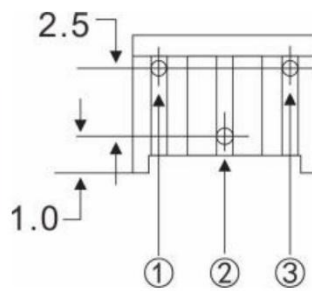

WTP-3362M

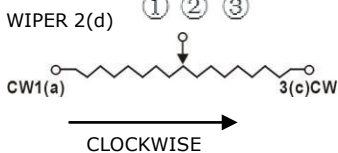
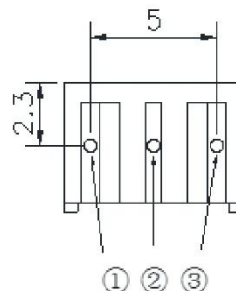

Tolerance is ±0.25 if no identification



SPECIFICATIONS

Electrical Characteristics	
Standard Resistance Range	10Ω - 5MΩ
Resistance Tolerance	±10% ; ±20% for 10, 20 and 2M ohm
Absolute Minimum Resistance	≤ ±1%R or 10Ω
Contact Resistance Variation	CRV ≤ ±3%R or 5Ω (whichever is larger)
Insulation Resistance	R1 ≥ 1GΩ(500Vdc)
Withstand Voltage	500VAC
Effective Travel	220°

Environmental Characteristics	
Power Rating (300volts max)	0.25W@70°C, 0W@125°C
Temperature Range	-55°C ~ +125°C
Temperature Coefficient	±250x10 ⁻⁶ /°C (±100ppm/°C on request)
Temperature Variation	-55°C,30min, +125°C30min, 5 cycles ΔR ≤ ±2%R, Δ(Uab/Uac) ≤ ±2%R
Vibration	10 - 500Hz, 0.75mm, 6hΔR ≤ ±1%R, Δ(Uab/Uac) ≤ ±2%R
Collision	390m/s ² , 4000cycles, ΔR ≤ ±1%R
Electrical Endurance at 70°C	0.25W@70°C 1000h, ΔR ≤ ±(5%R+0.1Ω), CRV ≤ ±3%R or 5Ω
Rotational Life	200 cycles ΔR ≤ ±(10%R+0.5 Ω), CRV ≤ ±3%R or 5Ω (whichever is larger)

Physical Characteristics	
Starting Torque	≤35mN·m
Marking	Resistance Tolerance (When no identification, it is of ± 10%) Resistance Code, Model
Standard Packaging	50pcs, per tube



PN STRUCTURE

WTP-3362W-103-R

<u>WTP</u>	<u>3362</u>	<u>W</u>	<u>103</u>	<u>R</u>
Series		Style	Resistance	RoHS
1		2	3	4

3. Resistance (Special Resistances Available)

Resistance Code	Resistance (Ohms Ω)	Resistance Code	Resistance (Ohms Ω)
100	10	203	20,000
200	20	223	22,000
500	50	253	25,000
101	100	303	30,000
151	150	333	33,000
201	200	473	47,000
251	250	503	50,000
301	300	683	68,000
471	470	104	100,000
501	500	154	150,000
681	680	204	200,000
102	1,000	224	220,000
152	1,500	254	250,000
202	2,000	304	300,000
222	2,200	334	330,000
252	2,500	474	470,000
302	3,000	504	500,000
472	4,700	684	680,000
502	5,000	105	1,000,000
682	6,800	205	2,000,000
103	10,000	225	2,200,000
153	15,000	505	5,000,000



WEE Technology Company Limited
FLAT/RM 705, 7/F, FA YUEN COMM
BLDG NO.75, FA YUEN STREET, MONG
KOK, KL, HONG KONG
www.weetcap.com
info@weetcap.com

All details in this data sheet are subject to change without notice.
For more details and updates, please visit our website.

Copyright © 2000 WEE Technology, All rights reserved.

